

# Panasonic

5.25inch Minifloppy Disk Drive

mei

MAR 17 1988

**JU-455**  
**JU-465**  
**JU-475**

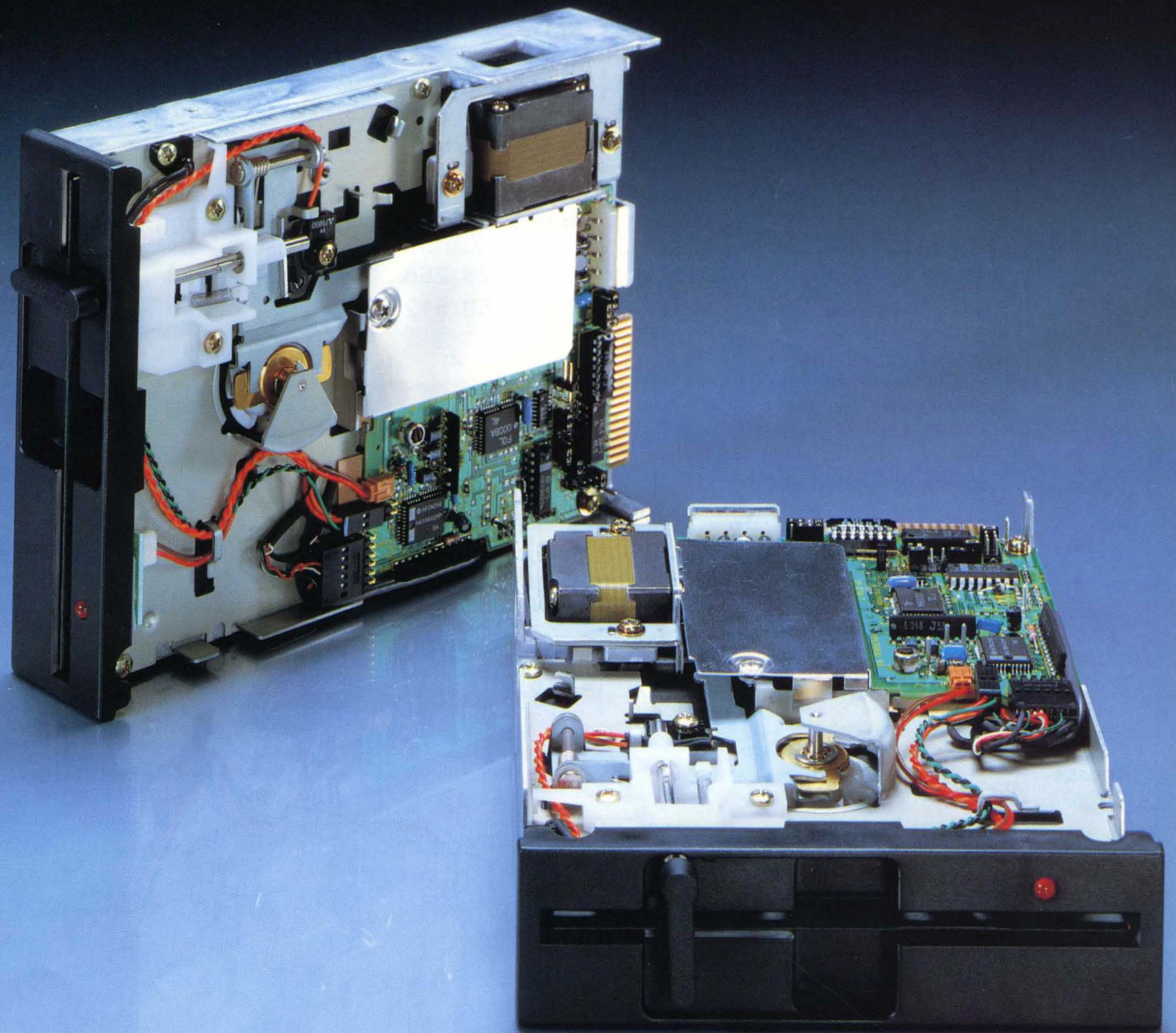

# SPECIFICATION SUMMARY

## Performance Specifications

Item				JU-455	JU-465	OBSOLETE JU-475	
						(Low)	(High)
Capacity	Total Storage Capacity/Disk	Unformatted (bytes)	FM	250,000	500,000	500,000	8,333,333/ 802,083
			MFM	500,000	1,000,000	1,000,000	1,666,666/1,604,167
		Formatted (bytes)	FM	163,840	327,680	327,680	614,400/ 591,360
			MFM	327,680	655,360	655,360	1,228,800/1,182,720
	Storage Capacity/Surface	Unformatted (bytes)	FM	125,000	250,000	250,000	416,666/ 401,041
			MFM	250,000	500,000	500,000	8,333,333/ 802,083
		Formatted (bytes)	FM	—	—	163,840	307,200/ 295,680
			MFM	—	—	327,680	614,400/ 591,360
	Storage Capacity/Track	Unformatted (bytes)	FM	3,125	3,125	3,125	5,208
			MFM	6,250	6,250	6,250	10,416
	Formatted (bytes)	FM	2,048	2,048	2,048	3,840	
		MFM	4,096	4,096	4,096	7,680	
Storage Capacity/Sector	Formatted (bytes)	FM	128/256	128/256	128	256	
		MFM	256/512	256/512	256	512	
Recording Density	Number of Heads			2	2	2	2
	Number of Tracks			80	160	160	160/154
	Recording Density(bpi)	FM		2,938	2,961	2,961	4,935/4,821
		MFM		5,876	5,922	5,922	9,870/9,642
	Track Density(tpi)			48	96	96	96
	Data Transfer Rate(K bits/s)	FM		125	125	125/150	250
MFM			250	250	250/300	500	
Access	Rotational Speed(R.P.M.)			300	300	300	360
	Track to Track Seek(ms)			4	3	3	3
	Settling Time(ms)			15	15	15	15
	Motor Start Time(ms)			500	500	500	500

## Power Specifications

Item		Rating		
Power Requirement	12 VDC	Voltage	12V $\pm$ 10% MaxRipple 100mVp-p	
		Current	Max.	0.6A/Peak 0.9A
			Typical	0.36A
	5 VDC	Voltage	5V $\pm$ 5% MaxRipple 50mVp-p	
		Current	Max.	0.65A
			Typical	0.5A
Environment	Temperature	Operating	10 to 46.1°C	
		Storage	-22.2 to 47.2°C	
		Shipping	62.2°C	
		Temperature Gradient	20°/H	
	Humidity	Operating	20 to 80% RH No Condensation	
		Non Operating	1 to 95% RH No Condensation	
Maximum Wet Bulb		29.4°C		
Vibration	Operating	Acceleration	0.5 G (No Soft Error)	
		Frequency	5 to 55 Hz (Except Resonant Point)	
	Non Operating	Acceleration	3.0G	
		Frequency	5 to 55Hz (Except Resonant Point)	
Shock	Operating	Acceleration	0.5G (No Hard Error)	
		Interval	10ms (Square Wave)	
	Non Operating	Acceleration	40G	
		Interval	10ms (Square Wave)	
Mechanical Dimension	Width	146.1mm (Except Front Bezel)		
	Height	41.5mm		
	Depth	203.2mm		
	Weight	1.3kg		
Mounting Angle	Vertical	0° to 20°		
	Horizontal	0° to 20°		
Dielectrical Withstanding Voltage	Between the Mounting Bracket and Signal Ground	250 VDC (1minute)		
Insulation Resistance	Between the Mounting Bracket and Signal Ground	250 VDC, >50 M $\Omega$		

## Reliability Specifications

Item		Rating
Drive	Mtbf	10,000 POH
	Mttr	0.5 hours
	Drive Life	5 years or POH
Error rate	Software Errors	10 <sup>-9</sup> /bit
	Hardware Errors	10 <sup>-12</sup> /bit
	Seek Errors	10 <sup>-6</sup> /seek

# ELECTRICAL INTERFACE

## Interface Connections

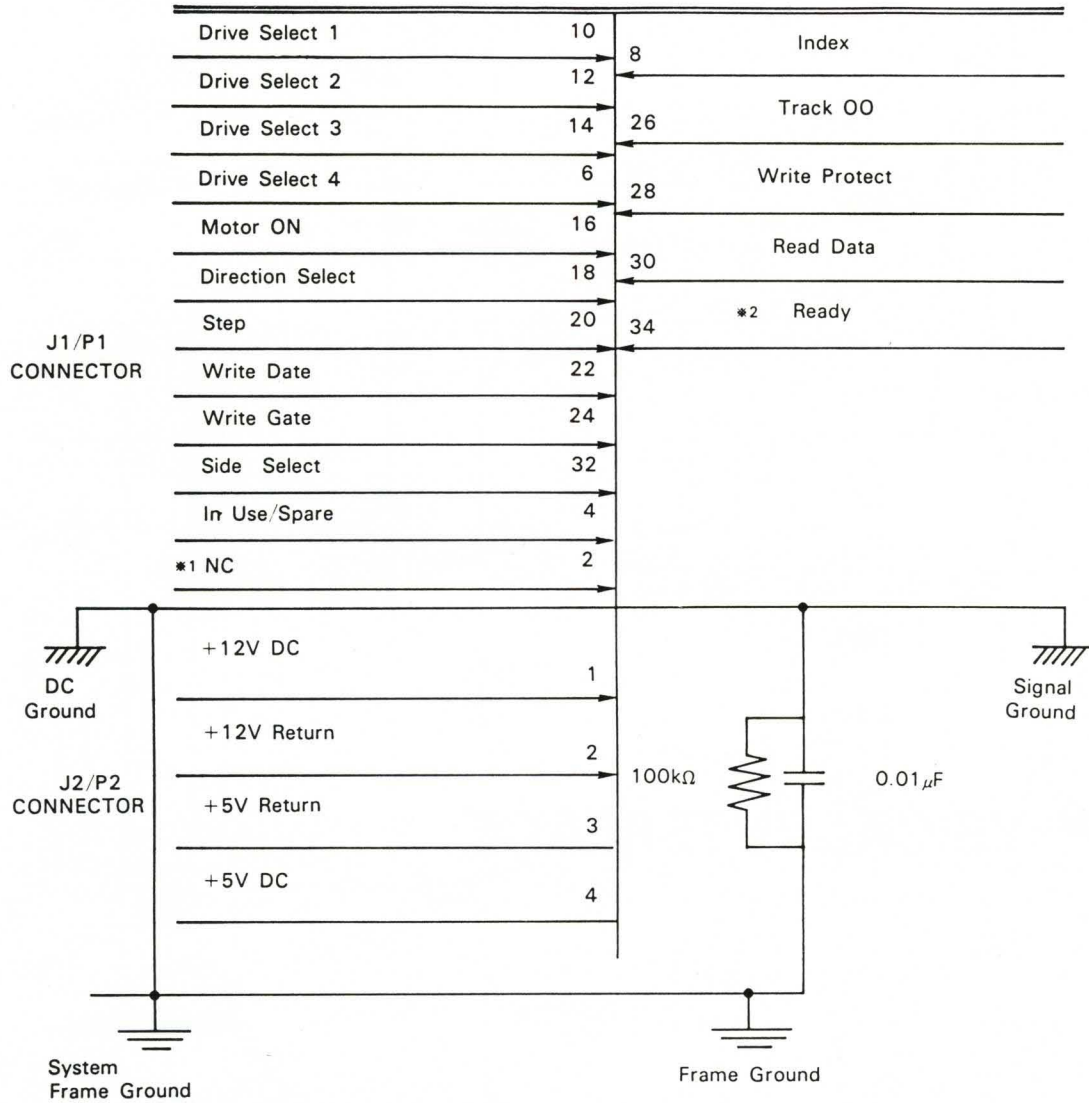

- \*1 Ju-475 : Mode Select
- \*2 Ju-475 : Ready/Drive Status

## Interface Signal Driver/Receiver

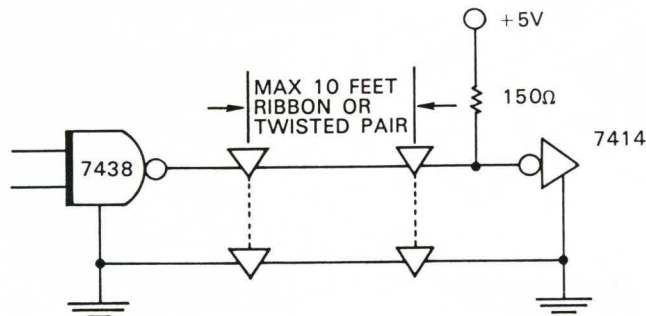

# DC POWER PROFILE

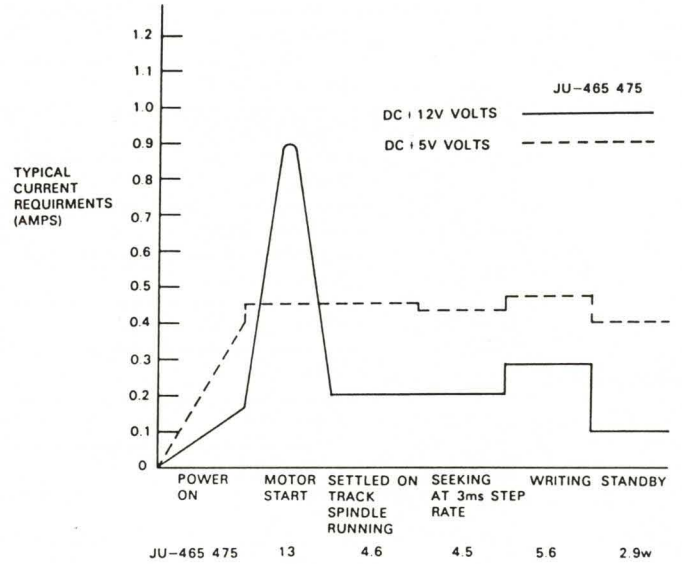
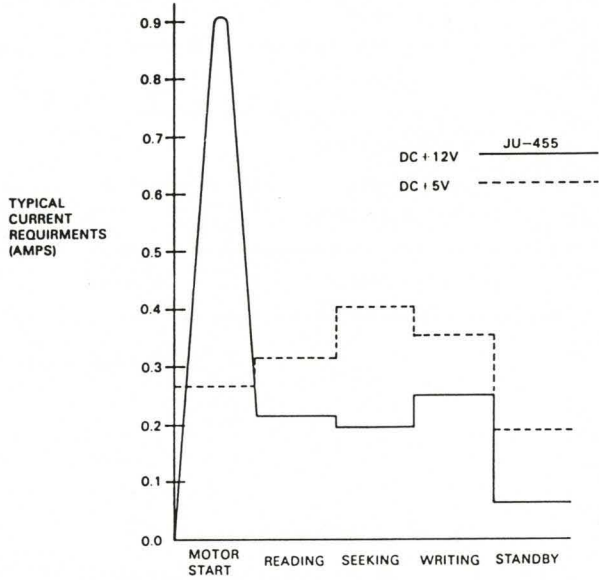

# PHYSICAL INTERFACE

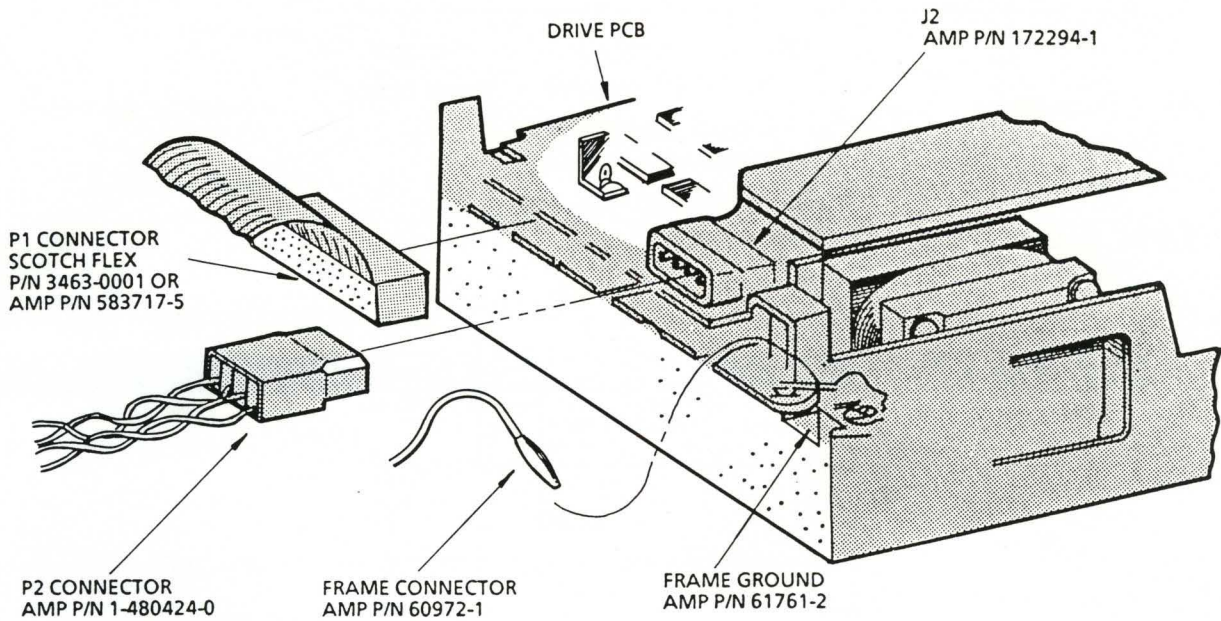

# MECHANICAL DIMENSIONS

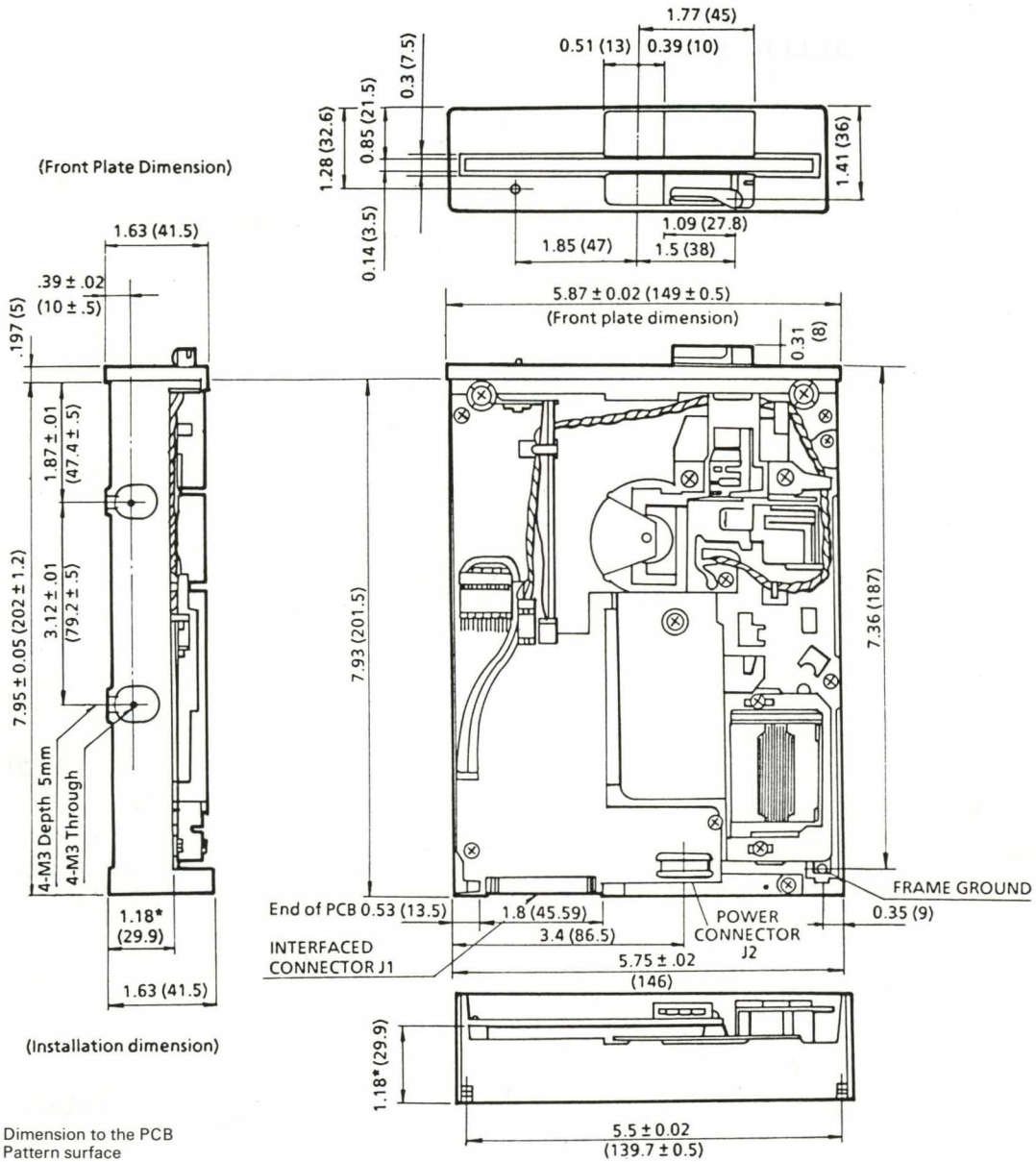

## MECHANICAL DIMENSIONS

For further details of each Model, please refer to the specification sheet.

# Panasonic